



intelligent Air Purifier

# Full intelligent Air Purifier Operation Manual

Operation Manual

## Contents

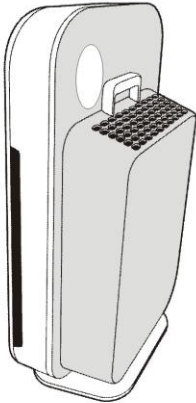

### Warranty card

	Purchase date	
Maintenance department	telephone	
Address		
Points for attention:	<ul style="list-style-type: none"> <li>● this machine will have one year warranty for free except artificial damage since purchasing date.</li> <li>● keep the receipt and warranty card in a convenient location</li> </ul>	
warranty record		

### quality tracking card

	client name	
telephone	address	
opinions after using		

to better meet users' need and to be more convenient for us to push new products information to you, please spare some to time to fill in this card and send it back to our company. Thank you very much for your support.

17

Problems	possible solutions
The machine does not work. The wind speed indicator lights up. Other indicators go out.	defect of the machine, call the After-sale center for help

Parameters of the product

Model	
Rated voltage	220v
Rated frequency	50Hz
Rated power	35W
Rated air flow	100~320m <sup>3</sup> /h
Rated noise	≤ 55db
Clean air delivery rate	260m <sup>3</sup> /h
Purification efficiency level	Class A
Applying area	26m <sup>2</sup>
Net weight	8.5kg
Dimension	640x352x190mm

All the parameters above have been tested according to GB/T 18801, GB 4706.1, GB 4076.45 standards.

1 安全注意事项	2	7 存储环境及保修服务	18
2 产品介绍	4	8 故障处理	19
控制面板	4		
产品简介	5	9 保修卡	20
3 使用前	6		
注意事项	6		
正确安装过滤网	7		
了解空气质量指示灯	9		
了解风扇速度指示灯	10		
4 使用方法	6		
自动模式	11		
手动模式	12		
5 保养和清洁方法	12		
清洁空气净化器	12		
清洁预过滤网	12		
清洁空气质量传感器	13		
6 更换过滤网	14		
维护过滤网	14		
更换过滤网锁定	15		
更换过滤网	16		

1.important safety instructions

To ensure your and others' safety, please read the instructions carefully before using this unit.

If the machine is out of order, contact your store of purchase or authorized Service Centre. no one other than an authorized repairman should take apart or repair the unit. (Doing so could lead to fire, electric shock or injury.)

 Warning



Do not plug in or unplug the unit connection plug with wet hands. Doing so could cause electric shock.



Be sure to unplug the plug from the socket when cleaning. Failure to do so could cause electric shock or injury.



This machine is designed exclusively for use of 220v alternating current power supply. Do not use it under other power supply system. Doing so could lead to fire or electric shock.



Before starting the machine, please well plug the plug in the socket. Failure to do so could cause electric shock or overheated or even fire.



Do not damage the connection power line. Do not cut or modify or over-twist of the power line. Do not tie up the power line while using this machine. Doing so could lead to fire or electric shock.



Clean the plug from time to time to remove the dusts, water or other things remain on the plug. Be sure to unplug the plug from the socket when not using the unit for long periods of time.



Do not modify or take apart the machine. Doing so could lead to fire, electric shock or injury.



Do not put any metal other stick-shaped objects near the air intake or air outlet. These things may get in touch with the metal elements inside the machine, causing fire, electric shock or injury.

troubleshooting

The following is the summary of the most common problems that you may meet during the utilization of this machine. If you could not solve the problems according to the information below, please contact the client service center.

Problems	possible solutions
The machine can not be started	you do not change the filter in time. You need to change the filter when the filter changing indicator starts twinkling. your machine may have been locked. Please change the filters and reset the machine.
No air coming out from the air outlet	The machine is not on. Start the machine properly Air quality is very good. The Auto mode is on. The machine will shut down automatically to save power when air quality is good.
Air coming out much more slowly than before	the pre-filter is very dirty. Please wash the filter The packaging of the filter has not been removed. Make sure you have removed all the packaging material
Air quality is not improved after working for long	You may forget to put one filter inside the machine. Please check if you have install all the filters properly. (refer to the operation manual) Air quality sensor is wet. There may be condensate water on the sensor. Please clean the sensor. The applying area exceeds much more than 26m <sup>2</sup>
Color of air quality ring and air quality I indicator remain the same	the sensor is too dirty., please clean the sensor there is not enough air ventilation inside the house, please open the window for a while
there is lots of noise while working	check if you have removed all the packaging materials.
The filters have been changed, but the filter changing Indicator keeps twinkling.	Check if you have reset the filter reset button
The machine stops working while power on Indicator is still on	the air quality is very good. There is no need to purifier the air.

take down the filter according to the steps shown in the pictures

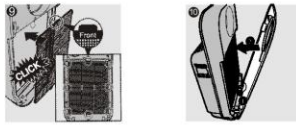
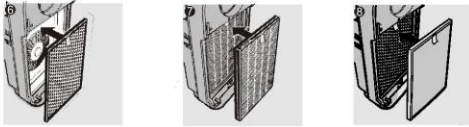

- 1** take down the filter reset button with a small tool.  
 Caution:  
 1 there is no need to press this button if you just clean the pre-filter.  
 2 while changing the filter, you can not do the reset before the filter changing indicator starts twinkling.  
 3 do the reset after power on and starting the machine

**Cautions**

Please unplug the connection plug immediately while any of the following situations shows up.

- Any of the buttons does not work.
- The disjuncter works or the fuse blows.
- The power wire or plug has abnormal heating.
- There is abnormal smell or noise.
- Any other unusual phenomena

**Cautions**

- Do not wipe the machine with oils, alcohol, benzene or thinner, or spray hairspray or insecticides on the machine. If such substances get on the machine, wipe them off immediately. Such substances could lead to cracking or electric shock or could catch fire.
- Do not pull the power wire while unplugging the plug. Pull directly the plug. Pull the power wire directly may cause short circuit or electric shock or fire.
- Do not use this machine in the kitchen or other place full of oily particles. This machine can not be used as air pump or ventilate equipment.
- ventilate the room if this machine and electric heater work together in it. Failure to do this may cause carbon monoxide poisoning. This unit can not get rid of carbon monoxide.
- Do not use this machine when using fuming insecticide. The insecticide may accumulate in the machine and be released from the air outlet. This may be harmful. Ventilate the room thoroughly after using insecticide, then use this machine.
- do not use this machine in a high temperature or moist place, for example in a bathroom. Doing so could lead to fire, electric shock or injury.
- Keep the machine dry. Failure to do so could lead to fire, electric shock or injury.
- Do not spill beverages or drop cigarette ashes, metal objects, easily burnable objects, etc., into the unit through the air outlet or air intake. Doing so could lead to fire, electric shock or injury.

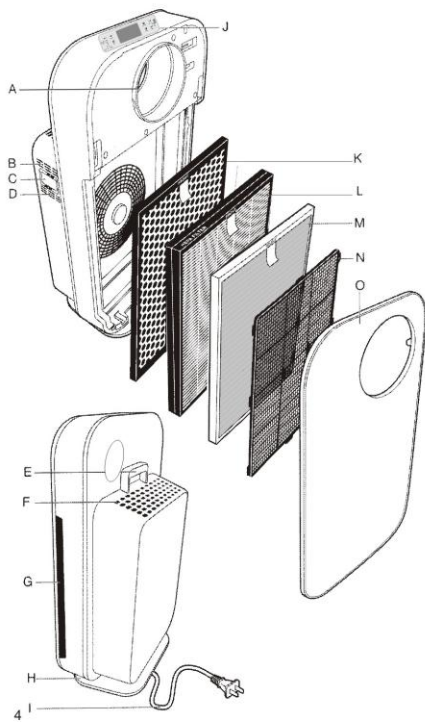

- 3** use wet cotton swab to clean the sensor the air intake and air outlet.  
 Use dry cotton swab to dry the sensor  
 Put back the protection cover

**Change filter**



If the working time accumulates to 4000 hours, the filter changing indicator will start twinkling, which means you will have to change the filter. Or the machine will be locked. One day before the lock of the machine, it will make a sound 'BiBi' every 30 minutes to remind you to change the filter.

Once the machine is locked, no matter which button you press, you will hear a sound 'BiBi'. You can press 'on/off' button to turn off the machine.

If the machine is locked:

- check if the filters needs to be changed
- turn off the machine and unplug the machine
- change the filters

take down the filter according to the steps shown in the pictures

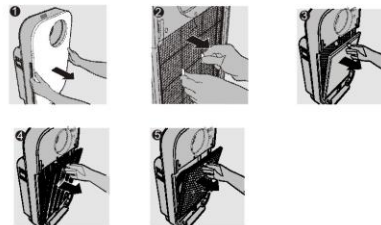

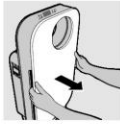

Use clean water or dust collector to get rid of dusts remains on the pre-filter. Please make sure the pre-filter is dry before putting it back into the machine.



**Clean air quality sensor**

To clean the air quality sensor at least once every two months to make sure the machine works in good condition. If it is used in a very dusty environment, clean the sensor from time to time.

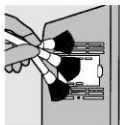

Caution: when air humidity inside the room is high, there may be condensate water remaining on the sensor. In this case, the sensor may not be able to detect the air quality accurately. Please clean the sensor to make sure the machine works in good condition.

1 clean the air intake and air outlet with a banister brush.

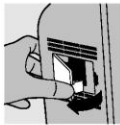

2 take off the protection cover of the sensor.

**Product introduction**

Thank you for purchasing this air purifier. With this living room using equipment, you can breathe cleaner air!

**Multiple filtering system**

This living room using air purifier has very special multiple filtering system. Using this machine can guarantee good air quality.

The first-fold filtering: the pre-filter which has been antibacterially treated can filter hair, pet hair and other big objects.

The second-fold filtering: the 'formaldehyde killer' filter can filter formaldehyde and other volatile organic compounds (VOC).

This filter can get rid of dusts, allergen, bacteria, and other tiny particles including some kinds of virus bigger than 20 nm. The size of bird flu, human flu virus is bigger than 20 nm according to WTO.

The third-fold filter: the HEPA filter has antibacterial coating that can get rid of tiny dust. This organic antibacterial material has also anti-mildew function which can filter mycetes.

The fourth-fold filter: the activated carbon filter can remove odor.

**Parts name (picture 1)**

- A air quality ring
- B D air quality sensor detecting port
- C air quality sensor cover
- E handle
- F air outlet
- G air intake
- H base
- I power wire
- J display panel

- K filter 3: activated carbon filter
- L filter 2: HEPA filter
- M filter 1: formaldehyde killer filter
- N filter: pre-filter
- O the front cover

**Cautions**

Please read this manual carefully before using this air purifier. After reading, keep the manual in a convenient location for future reference.

**Danger:**  
Do not use water or other kinds of liquid to clean the machine. Doing so could cause electric shock or fire.

- warnings:**
- If the power line is broken, contact the manufacture or after-service center to do the replacing work.
  - If there is damage of the plug or power wire or the machine itself, please do not use this machine.
  - This appliance is not intended for use by persons (including children) with reduced physical, sensory or mental capabilities, or lack of experience and knowledge, unless they have been given supervision or instruction concerning use of the appliance by a person responsible for their safety.
  - Children should be supervised to ensure that they do not play with the appliance.
  - Do not block the air intake or the air outlet. For example do not put any object in front of the air intake or on the air outlet.

- Cautions:**
- place this unit in a dry, stable, flat place and then start to use it.
  - Do not put any object on top of this unit. Do not sit on the machine.
  - Do not place this machine right under an air conditioner. There may be water dropping on the machine.
  - Make sure that all the filters have been right installed before starting the machine.
  - Use filters specially designed for this machine. Do not use other kinds of filters.
  - Do not beat the machine especially the air intake and air outlet with other hard objects.
  - Do not put fingers or other objects into the air outlet.
  - Do not use this machine when using fuming insecticide or in a place full of fire gases.
  - Do not use this machine near a heater or a stove.

**Intelligent mode**



Start the machine, the air quality sensor will detect the air quality automatically. The machine will change working power according to the air quality to guarantee the air quality inside the house and save power. In this mode the intelligent mode indicator lights up, the wind speed indicator indicates the wind speed.



You can choose the wind speed as you want if you do not want to use the intelligent mode, just press the wind speed button to choose the right wind speed. The wind speed indicator indicates the wind speed.

**Silent mode**



Start the machine and choose silent mode. When working in this mode, the machine works with very little noise. The silent mode indicator lights up and the other indicators go out. The machine works with low wind speed.



**Cleaning and maintenance**  
When filter changing indicator lights up, the filter needs to be cleaned. Please clean the pre-filter to make sure the machine works in good condition. Please take out the filter according to the steps shown in the picture below.

## Operation Manual

- on/off**  
plug the plug into the socket and make sure they are well connected. Caution: keep hands dry while doing this in case of electric shock. Unplug the plug while moving the machine. Press the on/off button, the machine starts working, the screen lights up and shows the working mode. Press again the on/off button, the machine stops working.
- Timer**  
Press the timer button to set working hours: choose to set 1h, 2h, 3h.....8h. The sign '---' means timer does not work, manual shutdown is needed.
- filter changing**  
press the button for 5 seconds. The timer for changing the filter will be set automatically. When working time accumulates to 3000 hours, the filter changing indicator will light up. Then you need to change the filter. After changing the filter, repress the button for 5 seconds to reset the timer.
- negative oxygen ion**  
press the negative oxygen ion button, the indicator lights up. The negative oxygen ion generator starts working. Press again this button, the indicator goes out and the generator stops working.
- HCHO killer**  
Press the HCHO killer button, the working power will increase to get rid of formaldehyde in the air.
- sleep mode**  
in sleep mode, the working power decreases, negative oxygen ion generator start working. The machine works with little noise
- start the machine, the default wind speed is low wind speed. Change wind speed by press the wind speed button. The wind speed indicator will show the wind speed.**

Press once	low speed wind
Press twice	middle speed wind
Press three times	high speed wind
- intelligent**  
press the intelligent button, the machine will work in intelligent mode.

10

## Operation Manual

- Do not use this unit in a place where are big changes of temperature. Doing so may cause condensate water on the sensor.
- Use this machine inside the house.
- This machine can not get rid of CO or Rn. It can not be used as a security equipment when fire or other accident happens.

### EMF

This machine meet all EMF standard. According to scientific test, this product is safe when using it properly referring to the operation manual.

### Before using

All the filters are provided with the machine. Please make sure to remove the packaging of the filter before using this machine. Please take apart the filters from the machine and remove the packaging according to the instructions below:



- put the finger on the dents on the side-cover. Pull the cover towards you to take apart the cover.



- take apart all the filters from inside the machine.



- remove all the packaging of the filters.

7

## Operation Manual

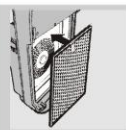

- put filter 3 back the machine. Make sure the side with plastic pull faces towards you.

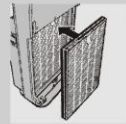

- put filter 2 back the machine. Make sure the side with plastic pull faces towards you.

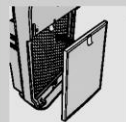

- put filter 1 back the machine. Make sure the side with plastic pull faces towards you.



- put the pre-filter back the machine. Make sure the side protruding edges faces towards you.



- put the cover back.

### Operations

- plug the plug in a socket.

8

## Operation Manual



- All the indicators will light up and go out in a second

- press the on/off button to start the machine



- air quality level can be shown on the screen



- air quality ring also shows air quality level

### Air quality ring

Color	air quality
Green	good
Orange	fair
Red	bad

### Air quality level standard

Air quality index	level	suggestion
20-70	good	people can exercise normally
70-150	fair	sensitive group avoid going outdoors
150-300	bad	avoid outdoor exercises

9